

Laser on
BLUM

MEASURING COMPONENTS

BLUM
focus on productivity

50
3350
im-n

Regional roots, international reach.

As a family-run company, we have deep roots in the region while also operating an international network of sales and service subsidiaries. From our sites in Grunkraut in Baden-Württemberg and Willich in North Rhine-Westphalia, we supply the machine tool, automotive, aerospace, energy and medical technology sectors, as well as numerous other demanding industrial areas across the globe.

We are always there wherever you need us – This has been our commitment to our customers for over 50 years.

Each of our products combines experience and expertise with an instinct for forward-looking solutions. A comprehensive service portfolio gives us an innovative edge and our customers the assurance of always receiving the best solution. Every day, more than 600 employees worldwide work to achieve this.

Your productivity is what drives us!



Alexander Blum

BLUM

CONTENTS

Mission Statement

Measuring Components

LaserControl

Tool Setting Probes

Touch Probes

Touch Probes DIGILOG

Surface Roughness Gauges RG

Software FormControl X

Bore Gauges BG

Sales & Service

International

NOVOTEST Test Engineering Division

Measuring Machines Division



LaserControl DIGILOG

The impressive performance of the LaserControl series has been ensuring maximum precision, reliability and efficiency in countless machining centres for decades now.

The latest generation is writing a new chapter in this success story. The trail-blazing DIGILOG technology opens up a multitude of previously unreachable applications in production measurement technology.

Page 10



High-Speed Touch Probes

Faster, more economic, more precise – the advantages of the high-speed touch probe series can be summarized as simply as that. The probes impress through their state-of-the-art measuring mechanism technologies and top measuring speeds. Specially designed for the harsh conditions in machine tools, they provide the right solution for any task.

Page 32

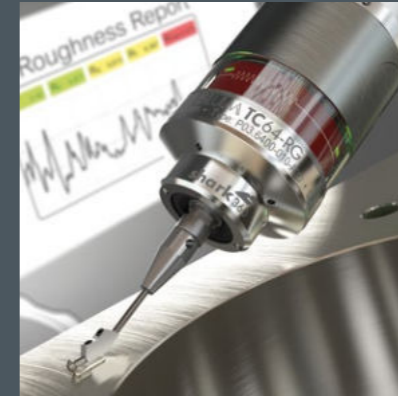

DIGILOG: Roughness Measurement and Scanning in the Machining Centre

The DIGILOG technology also enables touch probes to achieve standards previously thought impossible. While roughness gauges are used for precise and automatic inspection of workpiece surfaces, DIGILOG probes quickly and reliably scan complex workpiece contours in milling, turning and grinding machines.

Page 52



Worldwide Service

Profit from our comprehensive services to ensure maximum efficiency, in-process reliability and availability for your production. Our worldwide sales and service network enables us to provide optimum support and very short response times.

Page 76

01 OUR AMBITION IS YOUR PROFIT

BLUM-NOVOTEST, MISSION STATEMENT

Quality – Advanced and absolutely reliable solutions that meet the highest quality standards are at the heart of our company. Their sole function is to guarantee the efficiency of your manufacturing process.

Innovation – We see ourselves as technological pioneers and innovators in the field of measuring and testing technology. With us, you are always one step ahead.

Reliability – Our products stand for uncompromising precision in every environment. This means you are always on the safe side.

Personality – We foster long-term partnerships with our employees, customers and business partners. After all, fairness, trust and reliability are always built on mutual cooperation.

Commitment – Our comprehensive service extends far beyond the normal and is fully focussed on the individual needs of our customers. Your success is our success.

For over 50 years BLUM
has been creating products
that set standards.

There is a reason for that:
Passion





DIGILOG – one technology, many possibilities.

This is where components work together that belong together. Dependable sensor technology is essential for low-man-power, in-process reliability in production. In response to this, BLUM is already in a position to fulfil the demands that Industry 4.0 networked production will be making. DIGILOG technology will be playing a decisive role here: The future-oriented measuring systems open up revolutionary options for production processes because of the data pool generated through thousands of measuring values per second. They cover contour scans with DIGILOG touch probes, process-integrated roughness measuring, bore measuring devices for series production and of course tool measurement using DIGILOG laser measuring systems. The perfect interaction is reflected in the interface hardware as well. It is based on a modular system and can be modified extremely easily to accommodate further measuring systems.

02 LASERCONTROL SERIES

LASER MEASURING SYSTEMS WITH DIGILOG TECHNOLOGY

The laser measuring systems are the leading solution for non-contact tool setting and tool monitoring in machine tools. For over three decades, they have stood for consistent manufacturing quality and minimum downtime. In combination with the revolutionary DIGILOG technology, LaserControl's perfect protection, high-quality laser optics and intelligent electronics guarantee its tried-and-tested reliability and precision.



- AUTOMATIC MEASUREMENTS DELIVER HUGE TIME SAVINGS
- IN-PROCESS RELIABILITY UNDER COOLANT IN A NEW DIMENSION
- NON-CONTACT MEASUREMENT OF ALL TOOL TYPES, SHAPES, AND CUTTING MATERIALS
- RELIABLE COMPENSATION FOR SPINDLE DRIFT AND RUNOUT ERRORS
- IMPLEMENTATION OF CONTINUOUS PROCESS CHAINS
- ABSOLUTE ACCURACY BETTER THAN ALL COMPARABLE MEASURING SYSTEMS

02 LASERCONTROL SERIES TECHNOLOGY

The laser measuring systems guarantee maximum precision, reliability and efficiency in machining centres. The laser measuring systems attain that impressive performance thanks to their ground-breaking DIGILOG technology and innovative hardware.

DIGILOG Technology: In-process Reliability in a new Dimension

The DIGILOG laser measuring systems continuously measure the shading of the laser beam, generating thousands of measuring values as a result.

- DRAMATICALLY SHORTER MEASURING TIMES
- MAXIMUM PRECISION UNDER COOLANT
- AUTOMATIC RUN-OUT MONITORING
- ANALYSIS OF ANY SINGLE CUTTING EDGE

Technical data

LASER PROTECTION CLASS	Class 2 according to IEC60825-1, CFR 1040.10
LASER TYPE	Visible red light laser 630 ... 700 nm <1mW
PROTECTION CLASS	IP68

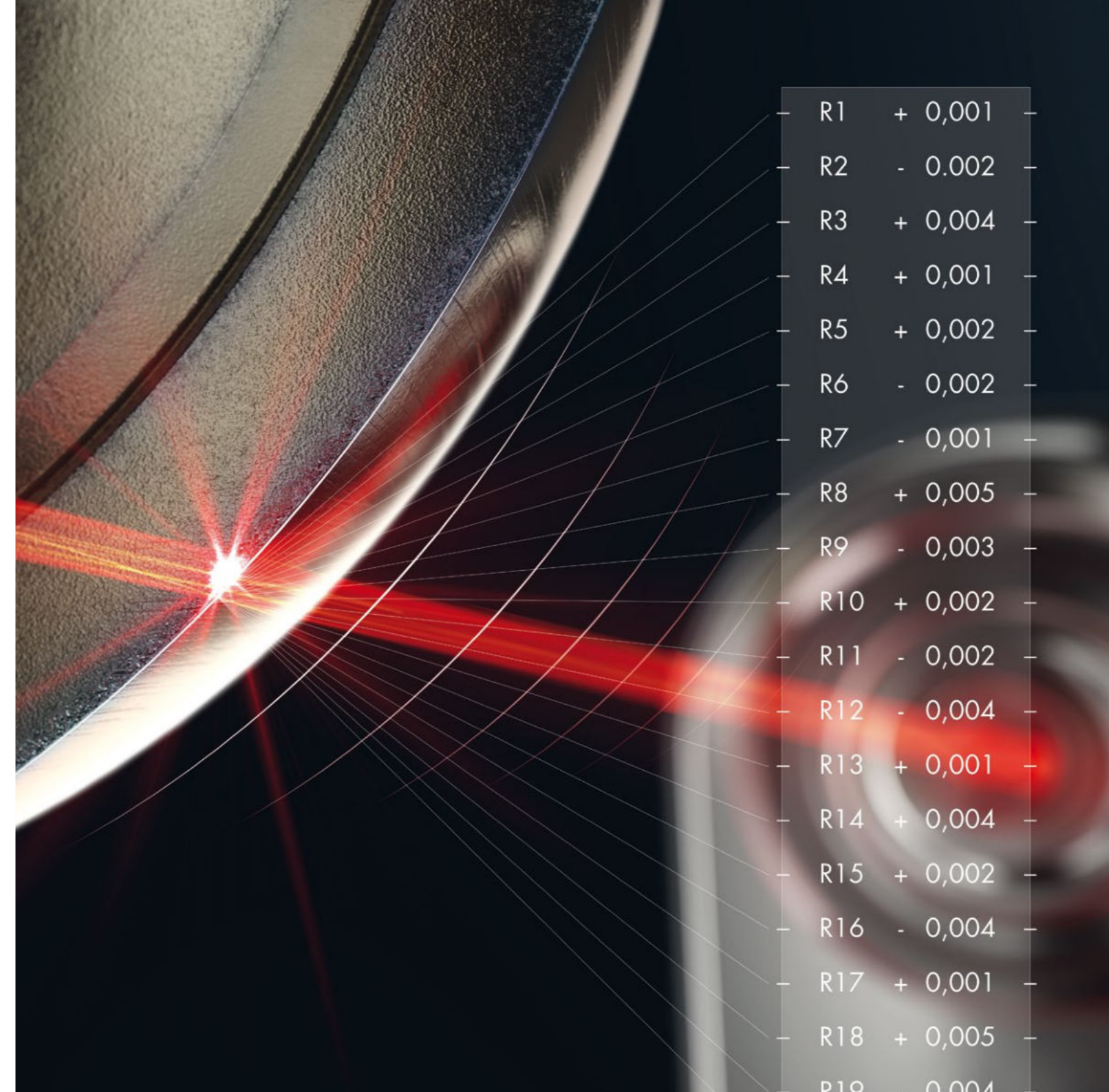

R1	+ 0,001
R2	- 0.002
R3	+ 0,004
R4	+ 0,001
R5	+ 0,002
R6	- 0,002
R7	- 0,001
R8	+ 0,005
R9	- 0,003
R10	+ 0,002
R11	- 0,002
R12	- 0,004
R13	+ 0,001
R14	+ 0,004
R15	+ 0,002
R16	- 0,004
R17	+ 0,001
R18	+ 0,005
R19	0,004

02 LASERCONTROL SERIES TECHNOLOGY

smartDock: Intelligent Variants for more Flexibility

This innovative interface serves as the basis for all new support systems and contains all the necessary pneumatic valves in addition to the electrical, mechanical and pneumatic connections between the machine and laser measuring system.

- ONE ELECTRIC & ONE PNEUMATIC LINE
- NO SEPARATE PNEUMATIC UNIT NEEDED
- SIMPLE LASER PREPARATION
- FLEXIBLY DEPLOYABLE INTERFACE FOR MACHINE INTEGRATION

Premium Laser Optics

- PRECISION BETTER THAN ALL COMPARABLE MEASURING SYSTEMS

HPC Nozzle

- FOR RESIDUE-FREE TOOL CLEANING

Unique Shutter System

- GUARANTEED RELIABLE OPERATION IN ANY MANUFACTURING SITUATION

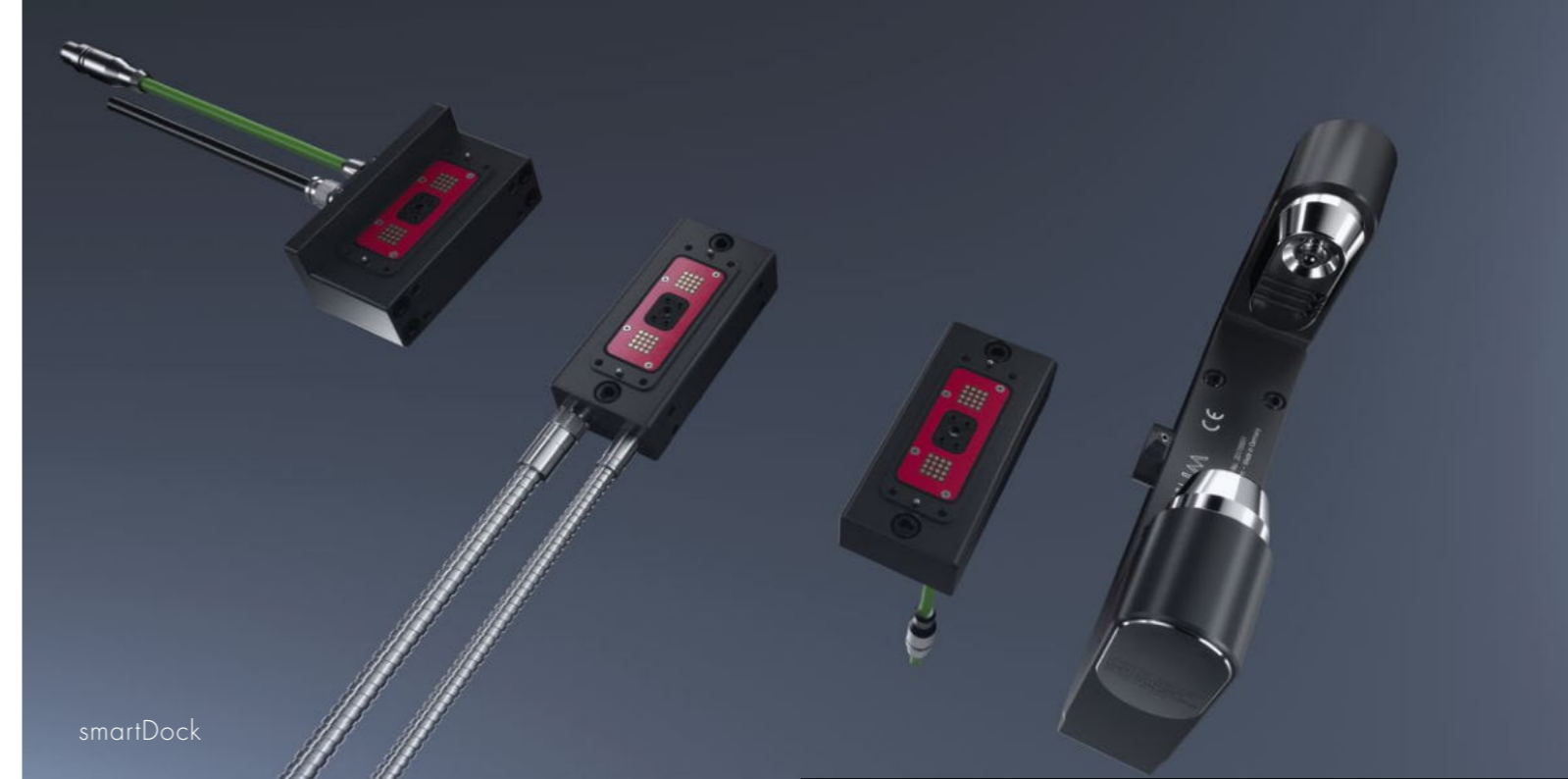

smartDock



Premium laser optics

Shutter system



Software LC-VISION

MEASUREMENT AND VISUALISATION SOFTWARE

LC-VISION is an innovative measurement and visualisation software for DIGILOG laser measuring systems from BLUM. Thanks to the intuitive operating concept, a wide range of measurement tasks can be generated, visualised and evaluated quickly and easily on the control screen. Here, the field of application is not limited to the topic of tool measurement, but also includes a reliable analysis of the motor spindle quality.

-  Tool Measurement
 -  Wear Compensation
 -  ToolControl
 -  SpindleControl
 -  OscillationControl
- and much more...

- STEP-BY-STEP PROCESS MAKES THE MEASURING SEQUENCE EASY EVEN WITHOUT NC PROGRAMMING KNOWLEDGE
- ONE USER INTERFACE FOR ALL COMMON MACHINE CONTROLS
- DIAGNOSTIC VIEW FOR DISPLAYING IMPORTANT SYSTEM DATA AND INFORMATION ON PREVENTIVE MAINTENANCE
- EXECUTION OF NEW TECHNOLOGY CYCLES SUCH AS SPINDLECONTROL, TOOLCONTROL ADVANCED OR OSCILLATIONCONTROL
- STABILITY FUNCTION FOR MACHINING UNDER THERMALLY STABLE SPINDLE CONDITIONS
- VISUALISATION AND STATISTICAL EVALUATION OF MEASUREMENTS
- DATA EXPORT OF MEASURED VALUES FOR PROCESSING IN TOOL MANAGEMENT SYSTEMS

Visualisation of the measurement results of a ball cutter

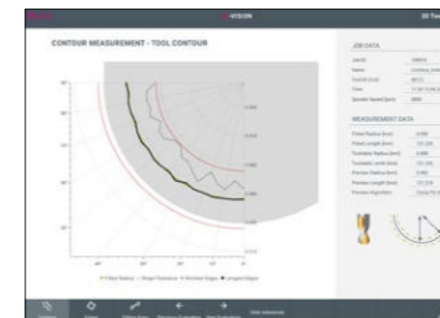

Example of a spindle parameter analysis

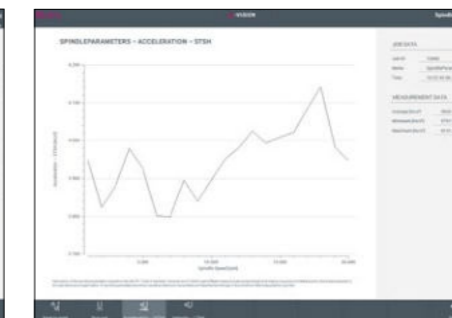



Laser Measuring System LC50-DIGILOG

PERFECTION IN TOOL MEASUREMENT

Unbeatably precise and reliable. In order to achieve the greatest possible accuracy in tool measurement in the machine tool, BLUM recommends the use of compact support systems. The laser measuring system LC50 is offered as standard in lengths from 150 to 500 mm. Thanks to the new laser optics, the system also meets the requirements of small high-end machines in micro-machining.

High-precision measurement of all tool types, sizes and shapes

Reliable solutions for every machining operation



-  NT Technology
 -  DIGILOG Technology
 -  Tool Breakage Detection
 -  Tool Setting
 -  Single Cutting Edge Monitoring
 -  Tool Form Measurement
 -  Wear Compensation
 -  Temperature Compensation
 -  RunoutControl
 -  MicroWearControl
 -  ConicalToolControl
 -  GrindControl
 -  ToolControl
 -  SpindleControl
- and much more...

System length LC50*	150 mm	200 mm	260 mm	300 mm
MAX. TOOL Ø**	36 mm	120 mm	314 mm	498 mm
MIN. TOOL Ø***	5****/15 µm	20 µm	30 µm	37 µm
REPEATABILITY***	0.2 µm 2σ	0.3 µm 2σ	0.4 µm 2σ	0.5 µm 2σ

* Additional system lengths: 400 and 500 mm ** Vertical/horizontal *** Depending on the installation situation and stability of mounting **** Contact with local BLUM representative is required

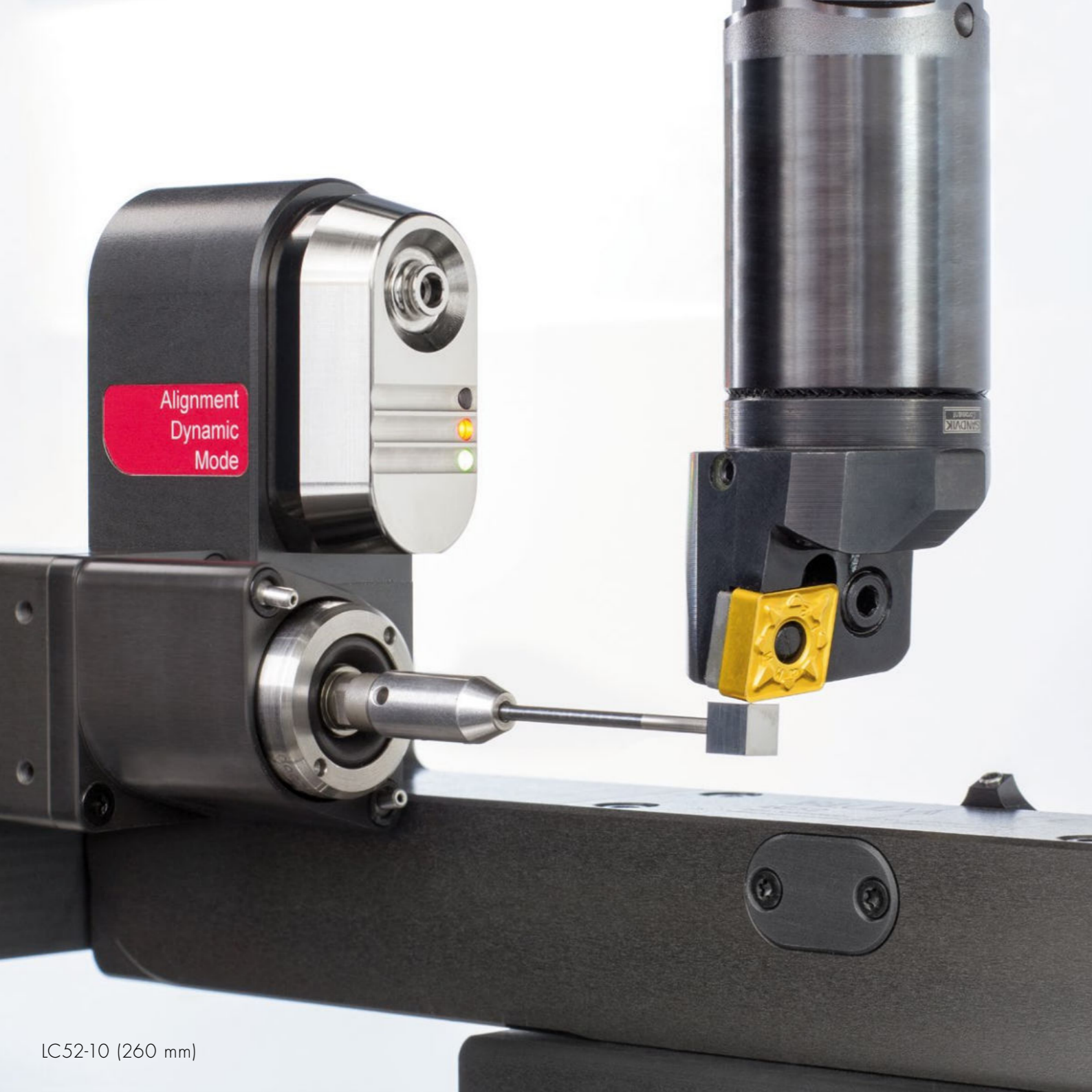

LC52-10 (260 mm)

Laser Measuring System LC52-DIGILOG

TOOL MEASUREMENT IN TURNING AND MILLING CENTRES

The complete solution for any tool. The LC52 is a compact, high-precision system for measurement of the complete tool spectrum in turning and milling centres. The measurement of milling tools via laser can be carried out contact-free under nominal rotation speed. Turning tools can be measured quickly and reliably with the adapted touch probe.

LC52-20 with pneumatically controlled protective sleeve (260 mm)



LC52-30 (200 & 260 mm)



-  NT Technology
-  DIGILOG Technology
-  Tool Breakage Detection
-  Tool Setting
-  Single Cutting Edge Monitoring
-  Tool Form Measurement
-  Wear Compensation
-  Temperature Compensation
-  RunoutControl
-  MicroWearControl
-  ConicalToolControl
-  GrindControl
-  ToolControl
-  SpindleControl
- and much more...

System length	200 mm	260 mm*	300 mm
MAX. TOOL Ø**	120 mm	314 mm	498 mm
MIN. TOOL Ø***	20 µm	30 µm	37 µm
REPEATABILITY***	0.3 µm 2σ	0.4 µm 2σ	0.5 µm 2σ

* Standard system length LC52-20: 260 mm ** vertical/horizontal
 *** Depending on the installation situation and stability of mounting

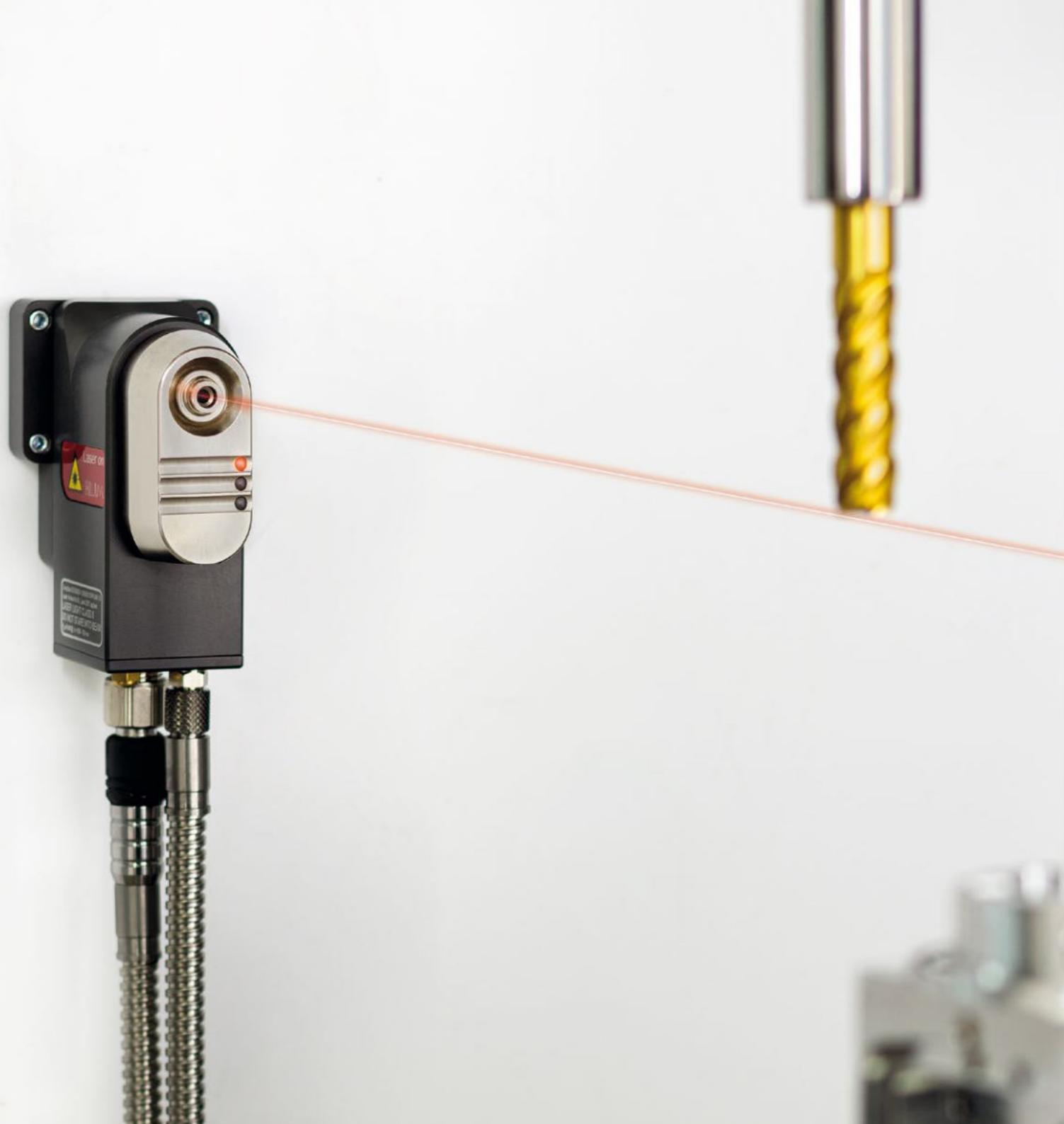

Laser Measuring System LC53-DIGILOG

SYSTEM WITH SEPARATE TRANSMITTER AND RECEIVER UNIT

If installation of the support systems is not possible for machine design reasons, the laser measuring system LC53-DIGILOG is used. The separation of transmitter and receiver allows for flexible integration into a wide variety of machines types.

Like all current laser measurement systems from BLUM, the LC53-DIGILOG also features the trend-setting DIGILOG technology, high-precision laser optics and the unique protection system.

Separate transmitter and receiver units provide flexible installation

Intelligent mounting set for easy installation

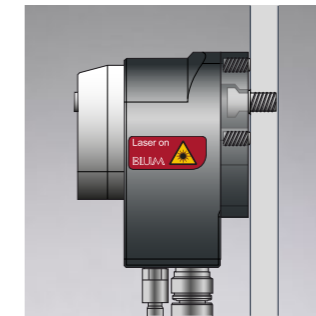

-  DIGILOG Technology
-  Tool Breakage Detection
-  Tool Setting
-  Single Cutting Edge Monitoring
-  Tool Length Measurement
-  Wear Compensation
-  Temperature Compensation

System distance	500 mm	1000 mm	1600 mm	2200 mm
MIN. TOOL Ø (for breakage)*	0.4 mm	0.5 mm	0.5 mm	0.7 mm
MIN. TOOL Ø (for measurement)*	1 mm	1 mm	1 mm	1.5 mm
REPEATABILITY*	2.5 µm 2σ	4.5 µm 2σ	6 µm 2σ	10 µm 2σ

* Depending on the installation situation and stability of mounting

03 **TOOL SETTING PROBES** TACTILE TOOL MEASUREMENT

The probe systems are used for fast and automatic tactile tool setting and tool breakage detection. Under the most adverse conditions, the systems are characterised by extreme durability, precision and economy. Thanks to state-of-the-art transmission technology, they represent the ideal add-on to BLUM workpiece touch probes.



- AUTOMATIC CALCULATION AND CORRECTION OF THE TOOL OFFSET
- AUTOMATIC BREAKAGE MONITORING BETWEEN MACHINING CYCLES
- NO SUBSEQUENT DAMAGES DUE TO TOOL BREAKAGE
- RELIABLE ALSO UNDER COOLANT
- ENABLE LOW-MANNED OPERATION

03 TOOL SETTING PROBES TECHNOLOGY

BLUM tool setting probes are characterised by state-of-the-art measuring mechanism technology featuring wear-free opto-electronic signal generation. The robust design enables maximum probing speeds with supreme precision. Fast, reliable data transfer is assured by infrared, BRC radio technology or cable connection.

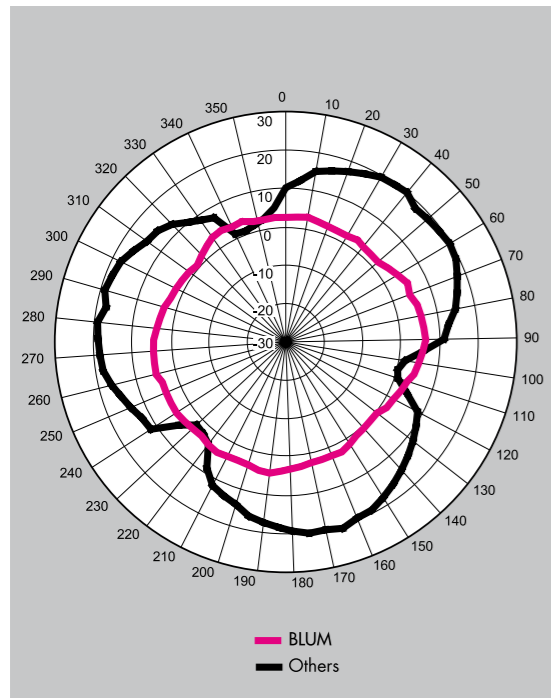

Multidirectional

Non-lobing touch characteristics with constant deflection forces.
ZX-Speed/IR/RC

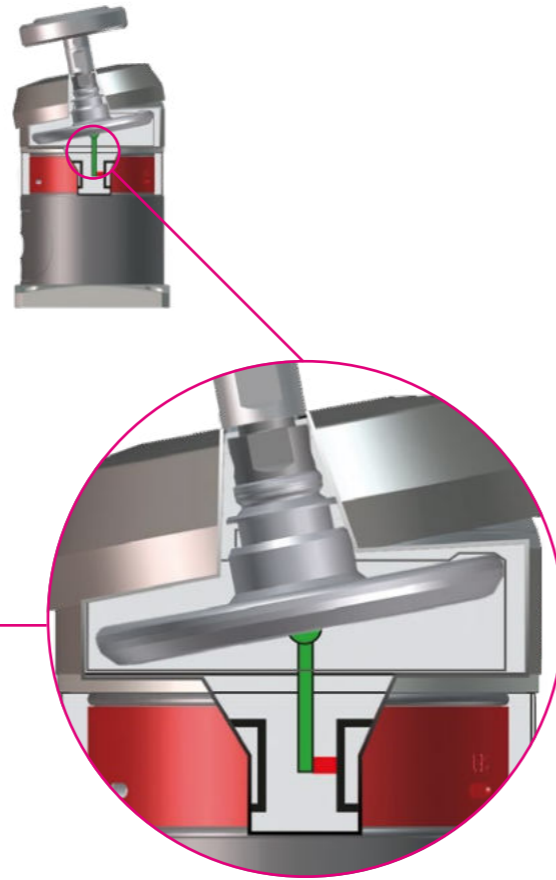

$\pm X, \pm Y, -Z$



Ball bearing mounted linear guide

The functional principle permits low measuring forces, and prevents lateral forces acting on the tool.
Z-Pico, Z-Nano/IR/RC

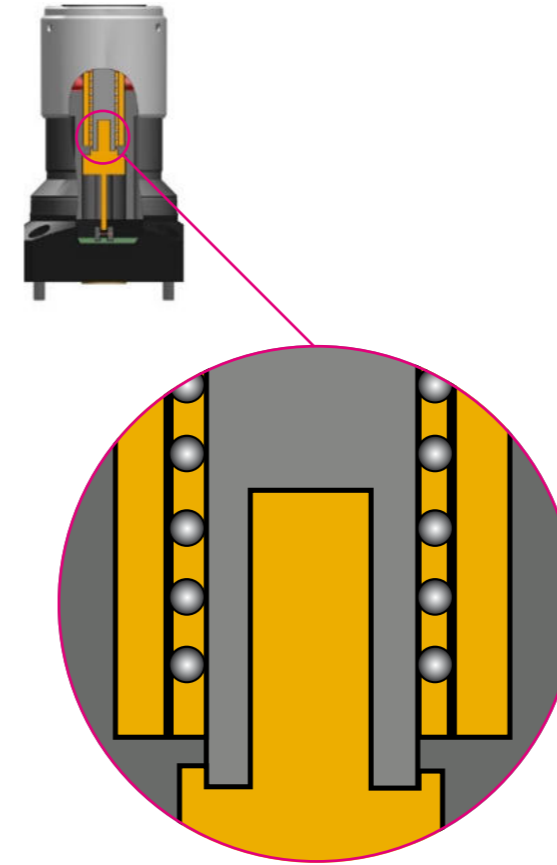

$-Z$



Multidirectional with face gear

The complete solution: High precision even in off-centre probing operations. Ideal for turning machines.
TC53/63, TC54/64, TC76

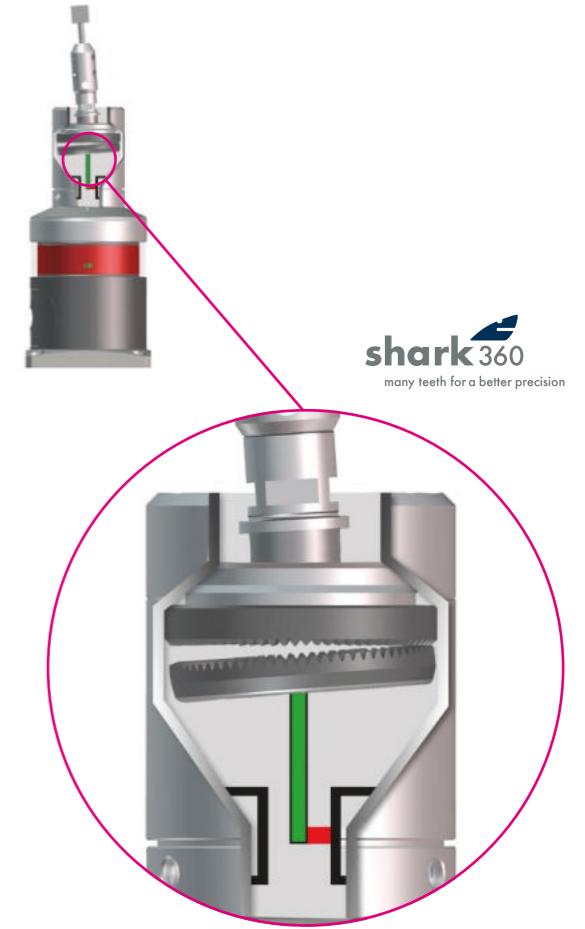

$\pm X, \pm Y, -Z$





Tool Setting Probes Z-Series

COMPACT TOOL MEASUREMENT

Robust and economic – the compact tool setting probes are extremely economic solutions for fast tool breakage detection and highly precise length measurements in machine tools. The well-proven design and the wear-free optoelectronic measuring mechanism with linear working principle, provide the highest reliability under the most adverse manufacturing conditions.

Z-Nano IR and Z-Nano RC
– the wireless versions

Z-Pico – for micro-machining



-  Linear Working Principle
-  Hardwired
-  Infrared Transmission
-  Radio Transmission
-  Tool Breakage Detection
-  Tool Length Measurement
-  Measurement with Coolant
-  Single and Mass Production
-  Wear Compensation
-  Temperature Compensation

Tool Setting Probe	Z-Pico	Z-Nano	Z-Nano IR	Z-Nano RC
HEIGHT	55 mm	75 mm	100 mm	100 mm
TRANSMISSION	Cable	Cable	Infrared	Radio
REPEATABILITY	1 μm 2 σ	0.5 μm 2 σ 0.2 μm 2 σ (HP)	0.5 μm 2 σ	0.5 μm 2 σ
MINIMUM TOOL \varnothing	0.05 mm*	> 0.1 mm* > 0.2 mm**	> 0.1 mm* > 0.2 mm**	> 0.1 mm* > 0.2 mm**

* Depending on the geometry and material of the tool, probing force must not result in damage of tool ** With chip protection



Tool Setting Probes **ZX-Speed Series** UNIVERSAL 3D TOOL SETTING PROBES

Versatile and economic – the 3D tool setting probe series comprises universally applicable probes for the measurement of length, radius and tool breakage in the machining centre. The robust probes use a modern, optoelectronic measuring mechanism which is outstanding in its unparalleled precision and longevity.

*ZX-Speed –
the cable-bound version*



Tool length measurement

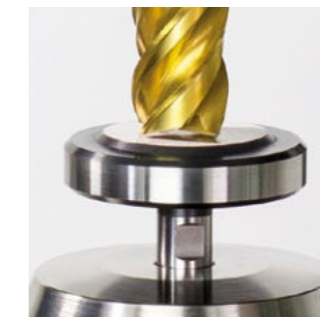

-  Multidirectional
-  Hardwired
-  Infrared Transmission
-  Radio Transmission
-  Tool Breakage Detection
-  Tool Length Measurement
-  Tool Radius Measurement
-  Measurement with Coolant
-  Single and Mass Production
-  Wear Compensation
-  Temperature Compensation

Tool Setting Probe	ZX-Speed	ZX-Speed IR	ZX-Speed RC
HEIGHT	63.5 mm	86 mm	86 mm
TRANSMISSION	Cable	Infrared	Radio
REPEATABILITY	0.4 µm 2σ	0.4 µm 2σ	0.4 µm 2σ
MINIMUM TOOL Ø	1 mm*	1 mm*	1 mm*

* Depending on the geometry and material of the tool, probing force must not result in damage of tool



04 TOUCH PROBES

PERFECTION IN WORKPIECE MEASUREMENT

The workpiece touch probes are used for fast and automatic workpiece measurement and workpiece referencing in machine tools. Specially designed for the harsh conditions in these machines, the probe systems are an effective solution for improving the accuracy of your workpieces and the productivity of your manufacturing lines. A range of different measuring mechanisms and design variants guarantee the right solution for any application.

- EXTREME PROBING SPEEDS
- MAXIMUM MEASURING ACCURACY
- RELIABLE ALSO UNDER COOLANT
- MECHANICALLY ROBUST DESIGN
- ENABLE LOW-MANNED OPERATION

04 TOUCH PROBES TECHNOLOGY

BLUM touch probes are characterised by state-of-the-art measuring mechanism technology featuring wear-free opto-electronic signal generation. The robust design enables maximum probing speeds with supreme precision. Fast, reliable data transfer is assured by infrared, BRC radio technology or cable connection.

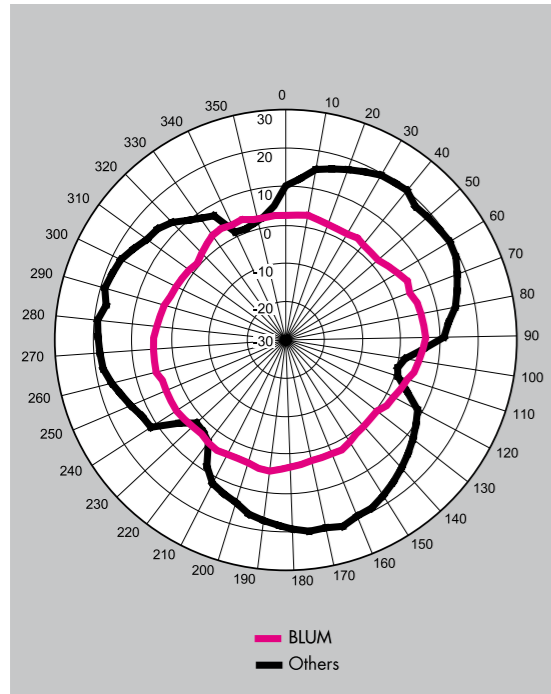

Multidirectional

Non-lobing touch characteristics with constant deflection forces.
TC50/60, TC52/62

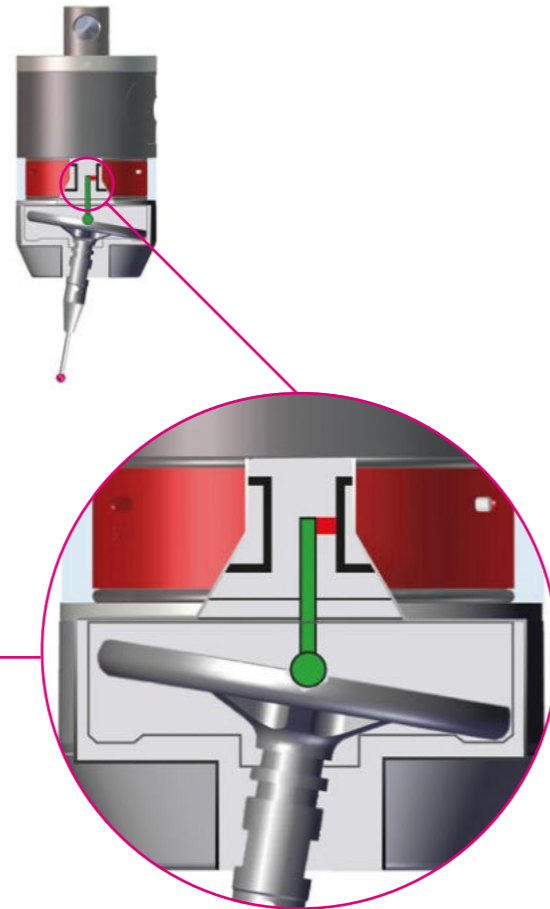

$\pm X, \pm Y, -Z$



Bidirectional

For high-speed pulling and pushing measurements.
TC51/61

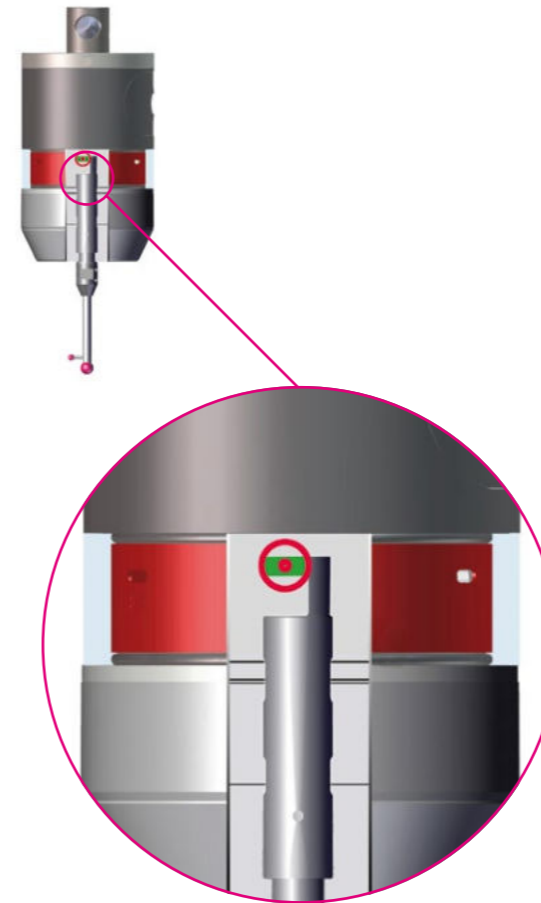

$\pm X^*, \pm Y^*, \pm Z$, * Via spindle indexing



Multidirectional with face gear

The complete solution: Also for pulling and pushing measurements in milling and turning machines.
TC53/63, TC54/64, TC76, TC63/64/76-DIGILOG, TC63/64/76-RG

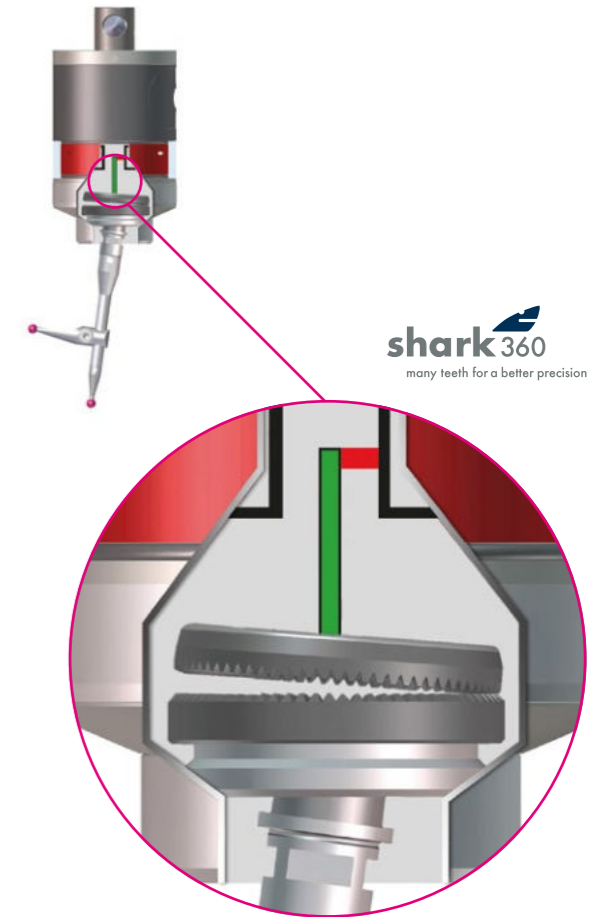

$\pm X, \pm Y, \pm Z$



DATA TRANSFER
TECHNOLOGY

Reliable and proven Transmission Technologies

The receiver systems guarantee fast and reliable wireless data transfer. Different systems are available, depending on the measuring system used and the required installation type.



Infrared Transmission

- VERY FAST AND SECURE TRANSMISSION IF THERE IS A LINE OF SIGHT TO THE RECEIVER
- SEQUENTIAL OPERATION OF TWO IR MEASURING SYSTEMS POSSIBLE WITH ONE RECEIVER
- IC57: EXTREMELY COMPACT IR-RECEIVER FOR MOUNTING IN THE SPINDLE CASTING



BRC Radio Technology

- FAST SIGNAL TRANSMISSION EVEN WITHOUT LINE OF SIGHT
- HIGH INTERFERENCE IMMUNITY THANKS TO BROADBAND TRANSMISSION
- NO INFLUENCE ON OTHER RADIO SYSTEMS
- SEQUENTIAL OPERATION OF UP TO 6 RADIO MEASURING SYSTEMS POSSIBLE WITH ONE RECEIVER





SYSTEM OVERVIEW TECHNOLOGY

BLUM offers the suitable data-interface variant for each measuring system and all common machine requirements. The interfaces control the devices, process the evaluation of the measuring values and display them clearly on the control screen or on an optional display. The possibility to store, statistically evaluate and visualize

the results is also optionally available. Furthermore, it enables an automatic process control by transferring measurement and compensation values to the machine control. The revolutionary DIGILOG functions are enabled by different extension modules (EM30/31/...).

OPERATING MODE **NT** — NC



IF10



BETRIEBSART **DIGILOG**



- EM30** PROFIBUS
- EM31** PROFINET & ETHERNET
- EM32** ETHERNET/IP & ETHERNET
- EM33** I/O, SSI, ANALOGUE, USB
- EM34** ETHERCAT
- EM35** CC-LINK IE FIELD BASIC



DIGILOG Functions

- Tool Measurement
- ToolControl
- SpindleControl
- and much more
- Workpiece Measurement
- Contour Measurement
- Roughness Measurement
- Bore Measurement
- Temperature Measurement



SIEMENS HEIDENHAIN FANUC

OPERATING MODE **TC** — NC



IF20



TP48-21
LC-VISION, RG, DIGILOG Contour scan, BG...





Touch Probes **TC50/52** | **TC60/62** HIGH-SPEED WORKPIECE MEASUREMENT

Faster, more economic, more precise - the advantages of this high-speed touch probe series can be summarized as simply as that. The multidirectional probes impress with the latest measuring mechanism technology featuring optoelectronic signal generation, the highest measuring speeds, and perfect, rotationally symmetrical probing behaviour with no preferential direction.

TC52, TC62 – for small machining centres

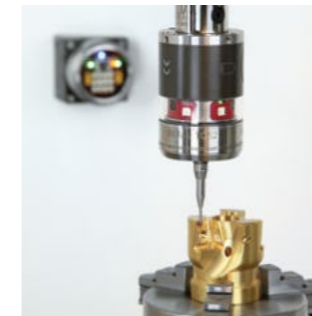
Ideal for single and mass production



-  Multidirectional
-  Infrared Transmission
-  Radio Transmission
-  Position Measurement
-  Measurement of Standard Features
-  Contour Measurement
-  Adaptive Machining
-  Measurement with Coolant
-  Wear Compensation
-  Temperature Compensation

Touch Probe	TC50	TC52	TC60	TC62
SIZE	Ø 63 mm	Ø 40 mm	Ø 63 mm	Ø 40 mm
TRANSMISSION METHOD	Infrared	Infrared	Radio	Radio
MAX. PROBING SPEED	3000 mm/min	2000 mm/min	3000 mm/min	2000 mm/min
REPEATABILITY	0.3 µm 2σ	0.3 µm 2σ	0.3 µm 2σ	0.3 µm 2σ



Touch Probes **TC51** | **TC61**

PULLING AND PUSHING MEASUREMENT

Perfect for fast machining centres – the touch probes were specifically developed for the requirements of highly productive machines. The unique bidirectional measuring mechanism with optoelectronic signal generation possesses a superior accuracy and permits measuring speeds of up to 5 m/min. The TC51 and the TC61 are the only touch probes worldwide, that allow quick pulling measurements in Z+ repeatedly and without wear.

Pulling and pushing measurements possible



TC51, TC61 – extremely fast and precise



-  Bidirectional
-  Infrared Transmission
-  Radio Transmission
-  Position Measurement
-  Measurement of Standard Features
-  Pulling Measurement
-  Adaptive Machining
-  Measurement with Coolant
-  Mass Production
-  Wear Compensation
-  Temperature Compensation

Touch Probe

TC51

TC61

SIZE

Ø 63 mm

Ø 63 mm

TRANSMISSION METHOD

Infrared

Radio

MAX. PROBING SPEED

5000 mm/min

5000 mm/min

REPEATABILITY

0.3 µm 2σ

0.3 µm 2σ



Touch Probes **TC53** | **TC63**

MODULAR TOUCH PROBES

Innovative, variable, highly precise. The modular TC53/63 series comprises versatile touch probe solutions in order to quickly adapt to complex, customer-oriented measuring tasks. All touch probes use the patented shark360 measuring mechanism which sets a new standard with regards to precision and reliability due to a modified face gear and the optoelectronic signal generation.

Mass production of gearbox housings



Measurement inside a turbine component



-  Multidirectional shark360
-  Infrared Transmission
-  Radio Transmission
-  Modular System
-  Position Measurement
-  Measurement of Standard Features
-  Pulling Measurement
-  Torsional Measurement
-  Adaptive Machining
-  Measurement with Coolant
-  Wear Compensation
-  Temperature Compensation

Touch Probe

TC53

TC63

SIZE

Ø 63 mm

Ø 63 mm

TRANSMISSION METHOD

Infrared

Radio

MAX. PROBING SPEED

2000 mm/min

2000 mm/min

REPEATABILITY

0.4 µm 2σ

0.4 µm 2σ

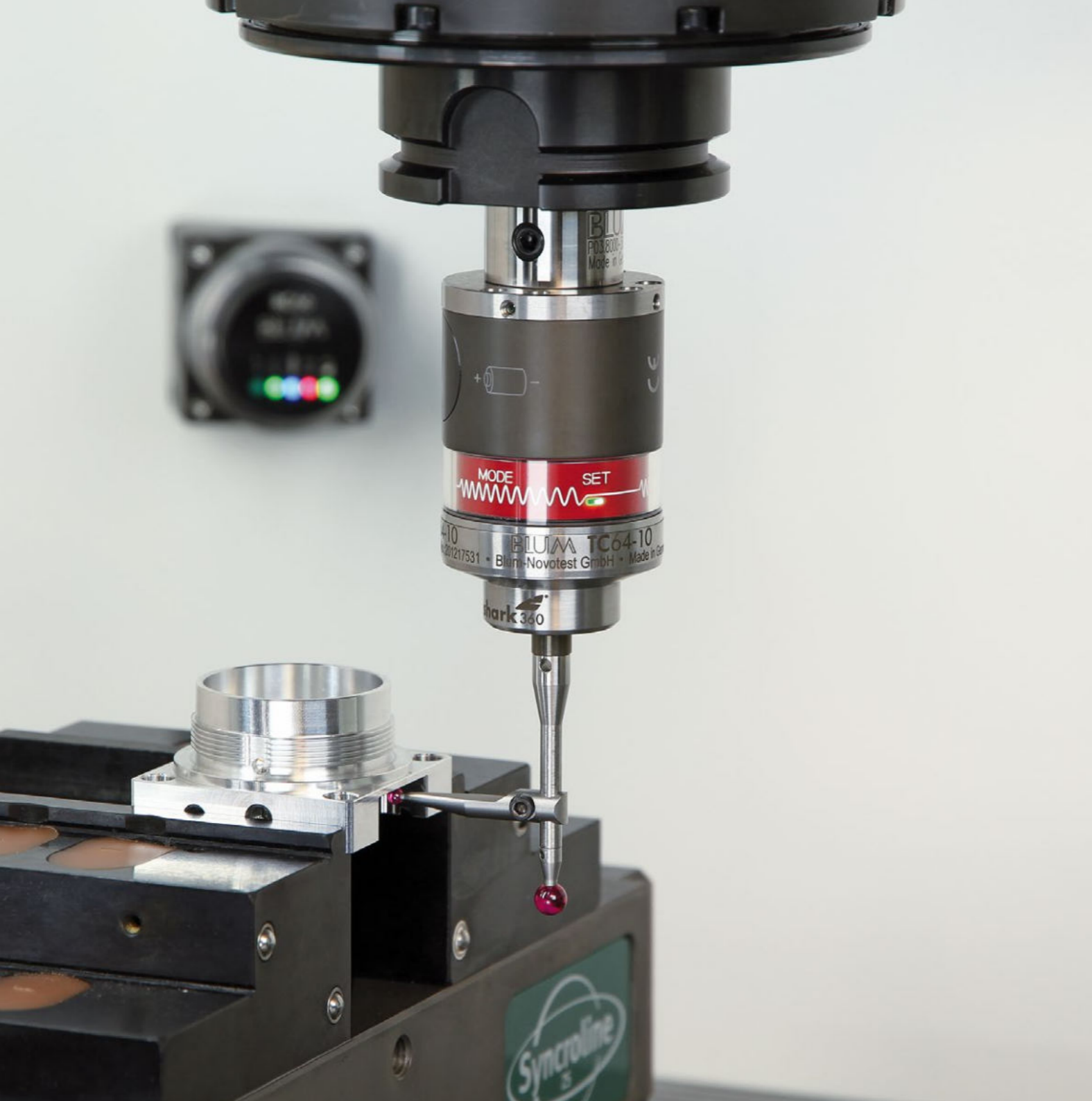

Touch Probes **TC54-10** | **TC64-10** FOR TURNING AND MILLING MACHINES

The touch probes TC54-10 and TC64-10 combine all advantages of the shark360 measuring mechanism with the compactness of a multidirectional BLUM standard touch probe. Due to the robust design and the wear-free, face-gearred measuring mechanism, the systems are perfectly suited for the measurement of tools and workpieces in turning and milling centres.

Workpiece measurement in the turning machine



Pulling and pushing measurement

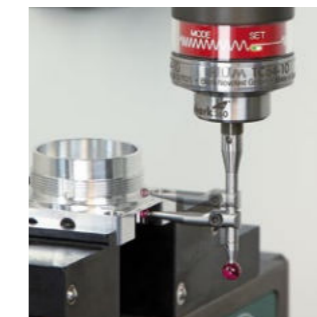

-  Multidirectional shark360
-  Infrared Transmission
-  Radio Transmission
-  Position Measurement
-  Measurement of Standard Features
-  Pulling Measurement
-  Torsional Measurement
-  Adaptive Machining
-  Measurement with Coolant
-  Tool Breakage Detection
-  Tool Length Measurement
-  Tool Radius Measurement
-  Wear Compensation
-  Temperature Compensation

Touch Probe

TC54-10

TC64-10

SIZE

Ø 40 mm

Ø 40 mm

TRANSMISSION METHOD

Infrared

Radio

MAX. PROBING SPEED

2000 mm/min

2000 mm/min

REPEATABILITY

0.4 µm 2σ

0.4 µm 2σ

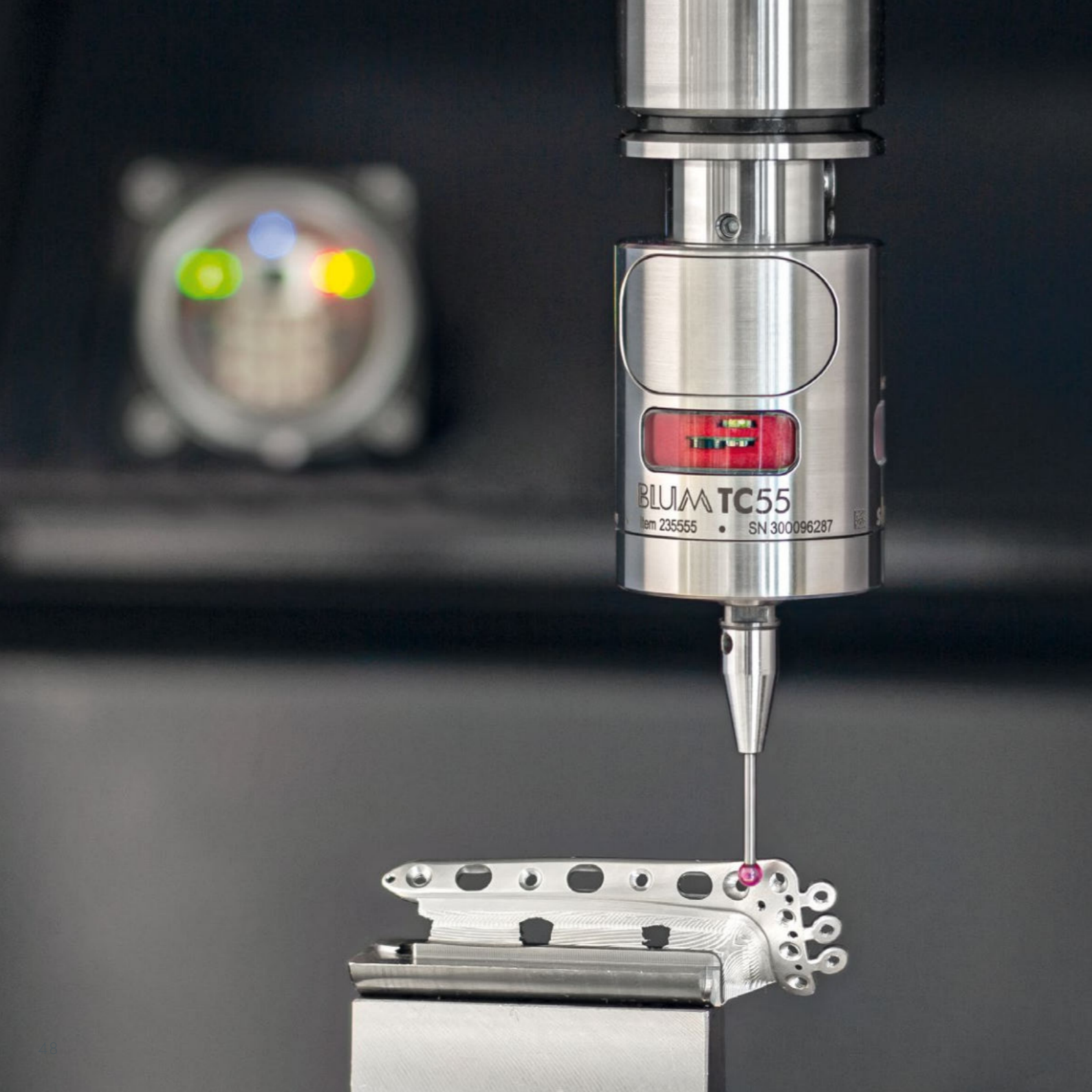

Touch Probe **TC55**



ULTRA-COMPACT VERSATILE

The TC55 touch probe is the smallest cable-free touch probe from BLUM so far. It is deployed in compact milling, turning and millturning centres that are used for microprocessing, medical technology and the measurement of components on machines for additive manufacturing. The integrated shark360 measuring mechanism enables pulling and torsional measurements when the offset stylus is used.

TC55 – the smallest wireless probe from BLUM

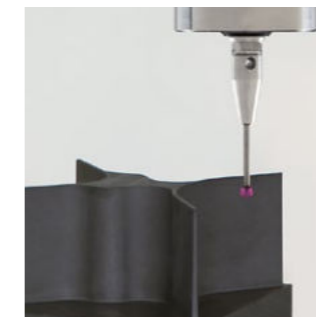
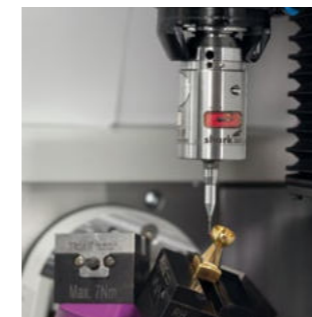
Perfect for delicate parts and small machining centres



-  Multidirectional shark360
-  Infrared Transmission
-  Position Measurement
-  Measurement of Standard Features
-  Pulling Measurement
-  Torsional Measurement
-  Adaptive Machining
-  Measurement with Coolant
-  Wear Compensation
-  Temperature Compensation

Touch Probe

TC55

SIZE	Ø 32 mm
TRANSMISSION METHOD	Infrared
MAX. PROBING SPEED	2000 mm/min
REPEATABILITY	0.3 µm 2σ

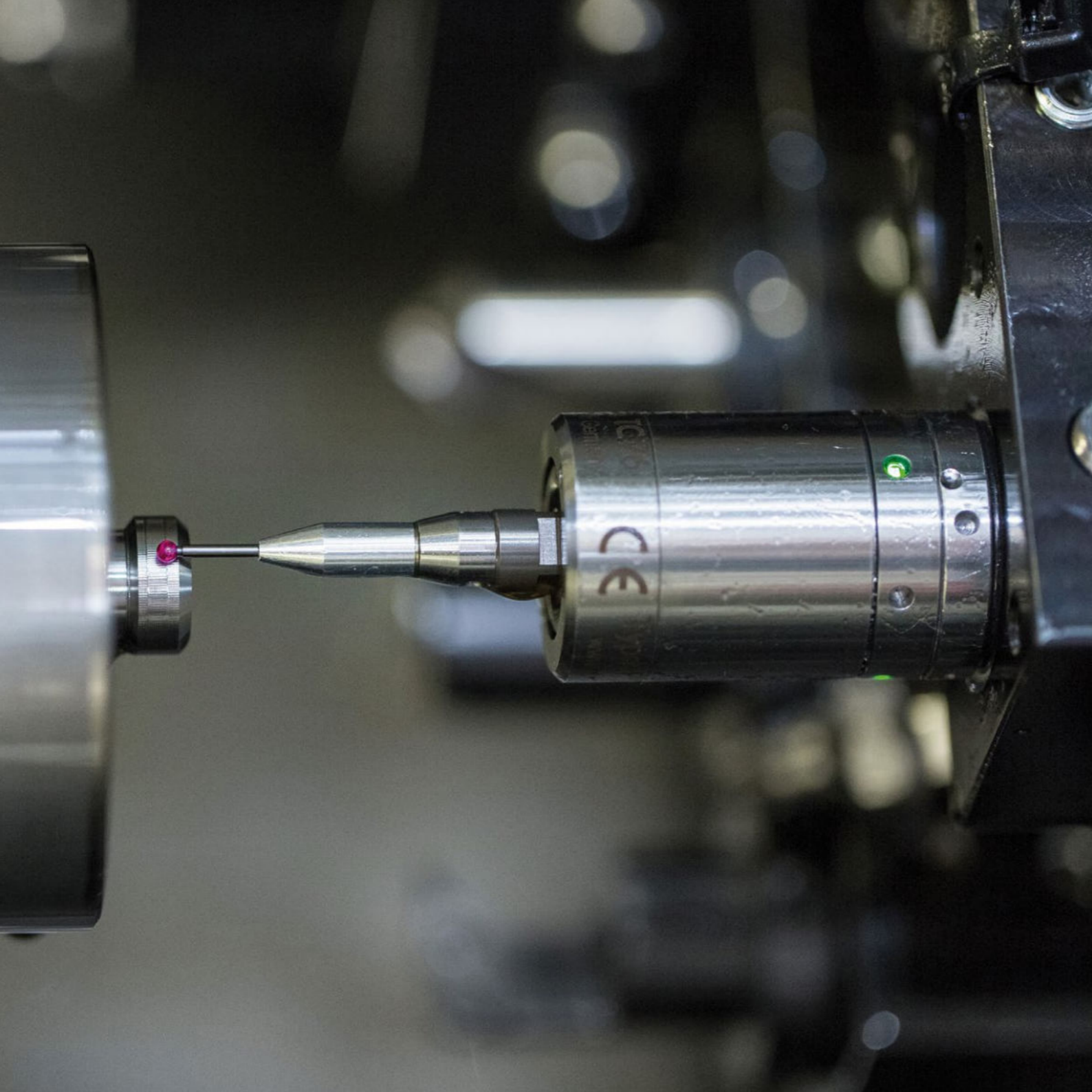

Touch Probe **TC76** ULTRA-COMPACT

The compact touch probe TC76 is used for a fast and automatic measurement of tools and workpieces in grinding, turning and milling centres. Due to a modified face gear and the optoelectronic signal generation, the built-in patented shark360 measuring mechanism sets a new standard with regards to precision and reliability.

Workpiece measurement in the turning machine



Tool measurement – TC76 with protective sleeve



-  Multidirectional shark360
-  Hardwired
-  Modular System
-  Position Measurement
-  Measurement of Standard Features
-  Pulling Measurement
-  Torsional Measurement
-  Adaptive Machining
-  Measurement with Coolant
-  Tool Breakage Detection
-  Tool Length Measurement
-  Tool Radius Measurement
-  Wear Compensation
-  Temperature Compensation

Touch Probe

TC76

SIZE	Ø 25 mm
TRANSMISSION METHOD	Cable
MAX. PROBING SPEED	2000 mm/min
REPEATABILITY	0.4 µm 2σ

05 DIGILOG TOUCH PROBES SCANNING WORKPIECE INSPECTION

DIGILOG touch probes by BLUM are used for fast and automatic inspection of workpiece contours in machining centres. Compared to switching measuring systems, analogue scanning measurement enables many more measuring points to be recorded in a fraction of the time. Complex contours can be monitored in series at up to 2 m/min. Using the measuring systems, machine setting errors can be detected, thus enabling fast reworking.

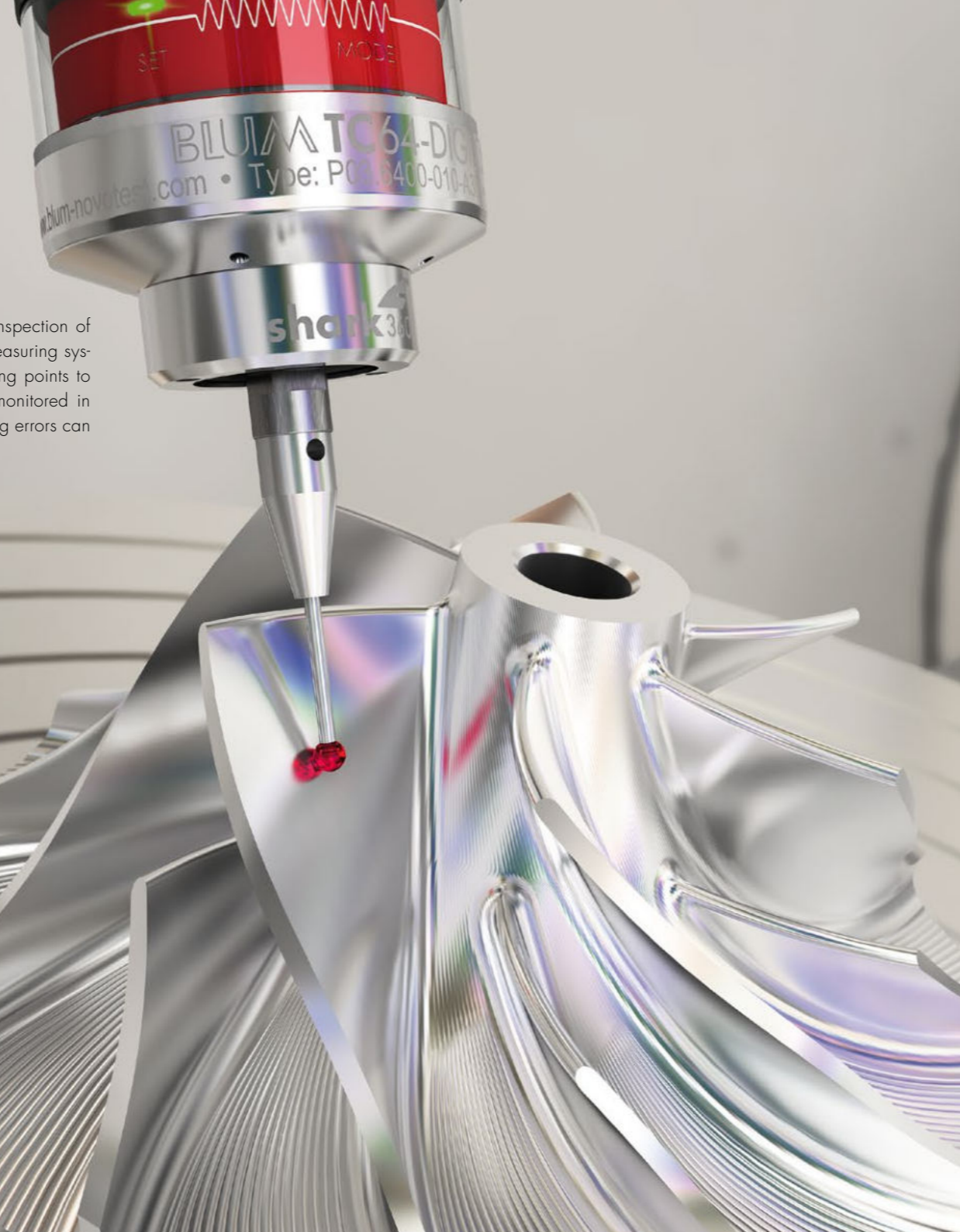

- DETECTION OF PROCESSING ERRORS BY ANALOGUE SCANS
- DIGITAL AND ANALOGUE TOUCH PROBE IN A SINGLE DEVICE
- HIGH SCANNING AND PROBING SPEEDS
- RELIABLE ALSO UNDER COOLANT
- IMPLEMENTATION OF CONTINUOUS PROCESS CHAINS



Touch Probes **TC63-DIGILOG** | **TC64-DIGILOG** THE DIGILOG REVOLUTION

DIGILOG = high-precision digital measurement and lightning-fast scans in analogue mode. Featuring BRC radio technology, the DIGILOG touch probes are particularly well suited to use in milling and turning centres. By analogue scanning of the workpiece surface, machining errors are detected quickly and reliably. The system is also available as a modular version in form of the TC63-DIGILOG.

Analogue contour scan of the sealing chamfer on a valve seat



TC63-DIGILOG – the modular system



-  shark360 DIGILOG
-  Radio Transmission
-  Modular System
-  Position Measurement
-  Measurement of Standard Features
-  ContourScan
-  Workpiece Inspection
-  Adaptive Machining
-  Measurement with Coolant
-  Mass Production
-  Wear Compensation
-  Temperature Compensation

Touch Probe

TC63-DIGILOG

TC64-DIGILOG

SIZE

Ø 40 mm

Ø 40 mm

TRANSMISSION METHOD

Radio

Radio

MAX. PROBING SPEED

2000 mm/min

2000 mm/min

REPEATABILITY

0.4 µm 2σ

0.4 µm 2σ

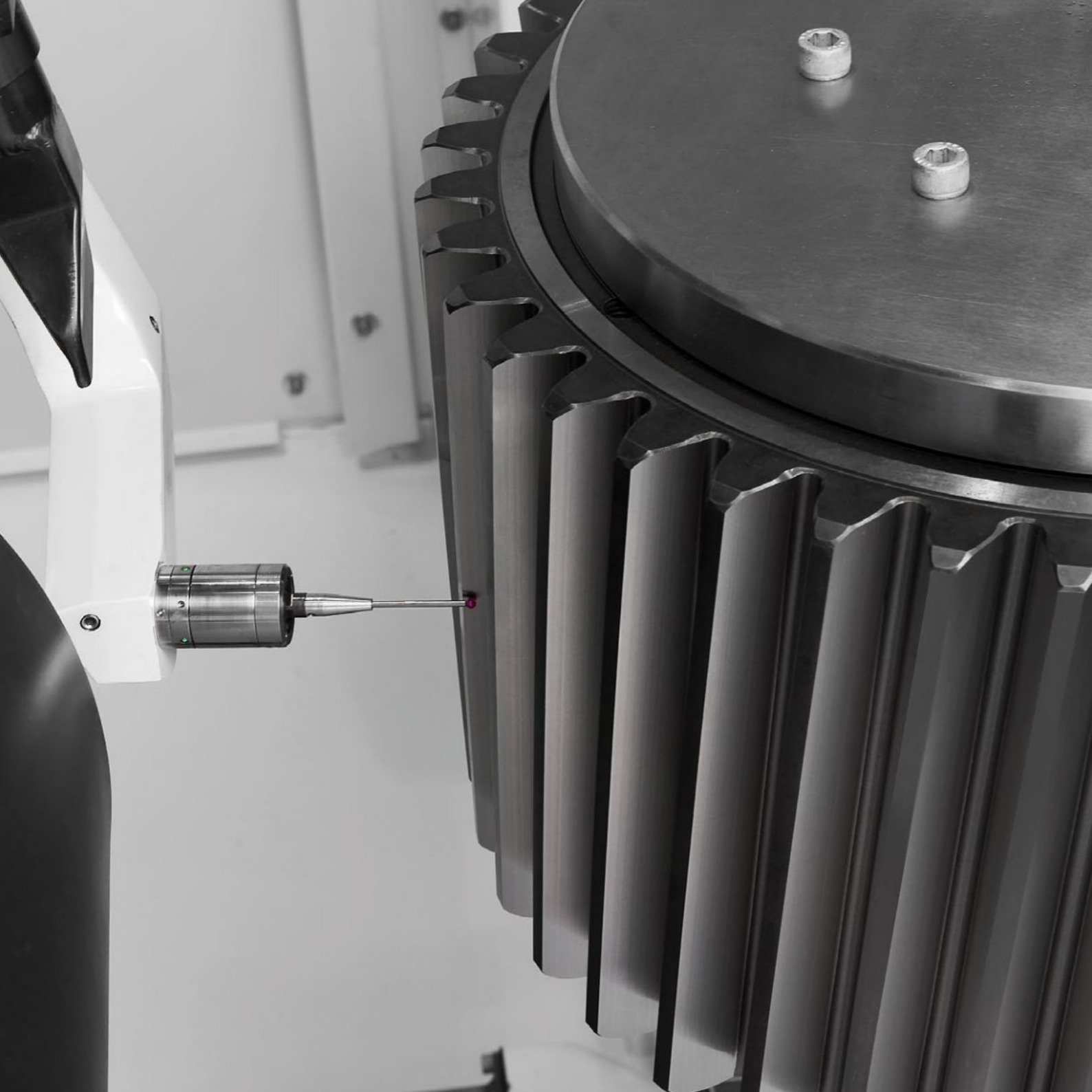

Touch Probe TC76-DIGILOG
DIGITAL MEASUREMENT & ANALOGUE SCANNING

Hard-wired touch probes for turning and grinding machines for automatic inspection of workpiece contours for machining errors. Exact measurement of workpiece position using digital measurement, extreme reduction in measuring time using lightning-fast, analogue scanning process

Detection of machining errors on gear grinding machine



Analysis on control monitor or BLUM Touch Panel

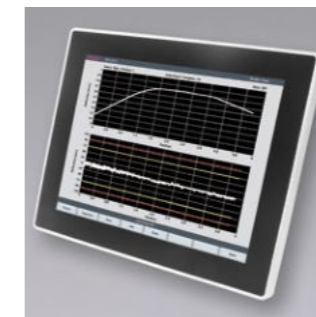

-  shark360 DIGILOG
-  Hardwired
-  Modular System
-  Position Measurement
-  Measurement of Standard Features
-  ContourScan
-  Workpiece Inspection
-  Adaptive Machining
-  Measurement with Coolant
-  Mass Production
-  Wear Compensation
-  Temperature Compensation

Touch Probe

TC76-DIGILOG

SIZE	Ø 25 mm
TRANSMISSION METHOD	Cable
MAX. PROBING SPEED	2000 mm/min
REPEATABILITY	0.4 µm 2σ

06

**ROUGHNESS GAUGES**

MACHINE-INTEGRATED MEASUREMENT

The DIGILOG roughness gauges are used for fast and automatic inspection of work-piece surfaces in milling, turning and grinding machines. Mostly in mass production, a wide range of different surfaces are inspected to within μm accuracy in just a few seconds and analysed according to the roughness parameters R_a , R_z and R_{max} . The measured roughness values are either logged for later use, outputted as status values, or visualised via the graphical interface.



- AUTOMATED ROUGHNESS MEASUREMENT IN MACHINING CLAMPING
- DIGITAL AND ANALOGUE TOUCH PROBE IN A SINGLE DEVICE
- MECHANICALLY ROBUST DESIGN
- RELIABLE ALSO UNDER COOLANT
- ENABLE LOW-MANNED OPERATION



Roughness Gauge **TC64-RG**

THE QUANTUM LEAP IN THE MACHINING CENTRE

Globally unique roughness measuring system for automatic inspection in the original fixturing. Fast digital measurement of workpiece position and reliable detection of poor surface quality using analogue measurement. The roughness parameters Ra, Rz, Rq, Rt, Rmax and Wt are outputted on the machine controller. In this way, rejects characterised by the feature "surface roughness" can be minimised.

TC64-RG – Roughness measurement in the machining centre



Analysis on control monitor or BLUM Touch Panel



-  shark360 DIGILOG
-  Radio Transmission
-  Position Measurement
-  Roughness Measurement
-  Workpiece Inspection
-  Measurement with Coolant
-  Mass Production

Roughness Gauge

TC64-RG

SIZE	Ø 40 mm
TRANSMISSION METHOD	Radio
MAX. PROBING SPEED	2000 mm/min
MEASURABLE ROUGHNESS	> Rz 2 µm



Roughness Gauges **TC63-RG** | **TC76-RG** MODULAR VARIANTS

The modular roughness gauge TC63-RG permits adaptation to customer-specific tasks. The single measuring element version delivers maximum measurement accuracy with lower measuring force, and was developed specially for inspection of straight workpiece geometries in milling, turning and grinding machines. Bad surfaces, caused by worn tools, are detected in-process.

TC63-RG – modular system with shark360 DIGILOG technology



TC63-RG with single-measuring element



-  shark360 DIGILOG
-  Hardwired
-  Radio Transmission
-  Modular System
-  Position Measurement
-  Roughness Measurement
-  Workpiece Inspection
-  Measurement with Coolant
-  Mass Production

Roughness Gauge	TC63-RG	TC63-RG Single	TC76-RG
SIZE	Ø 40 mm	Ø 40 mm	Ø 25 mm
TRANSMISSION METHOD	Radio	Radio	Cable
MAX. PROBING SPEED	2000 mm/min	100 mm/min	2000 mm/min
MEASURABLE ROUGHNESS	> Rz 2 µm	> Rz 1 µm	> Rz 2 µm

07



SOFTWARE FORMCONTROL X
RELIABLE PROCESS AUTOMATION

FormControl X is a user-friendly measuring software for automated quality control of workpieces on machining centres for automated quality control of workpieces performing individual and series production.

Its use enables maximum productivity reduction of scrap through control measurements between and after machining, statistical process control based on the recorded measured values and reworking in the original set-up.



- CREATION OF THE MEASUREMENT PROGRAMME BY MOUSE CLICK
- COMPLEX MEASUREMENTS IN THE MACHINING CENTRE
- PERFORM 5-AXIS MEASUREMENTS
- OUTPUT OF MEASUREMENT REPORTS AS A DOCUMENT AND IN JSON FORMAT
- INDEPENDENT END-DEVICE DISPLAY OF MEASUREMENT RESULTS IN THE WEB BROWSER

**BORE GAUGES**

EXTREMELY FAST BORE MEASUREMENT

The bore gauges are used in machine tools for fast and automatic measurement of workpieces with tight bore and fit tolerances in machine tools. The systems are able to reveal the full range of their strengths especially in mass production of workpieces with identical bore diameters, such as engine components – cylinder head and block, piston rod, valves, ...

or hydraulic components. Extremely short measuring times with maximum precision are guaranteed thanks to the stand-alone analogue measuring mechanism which operates independently of the machine's accuracy.

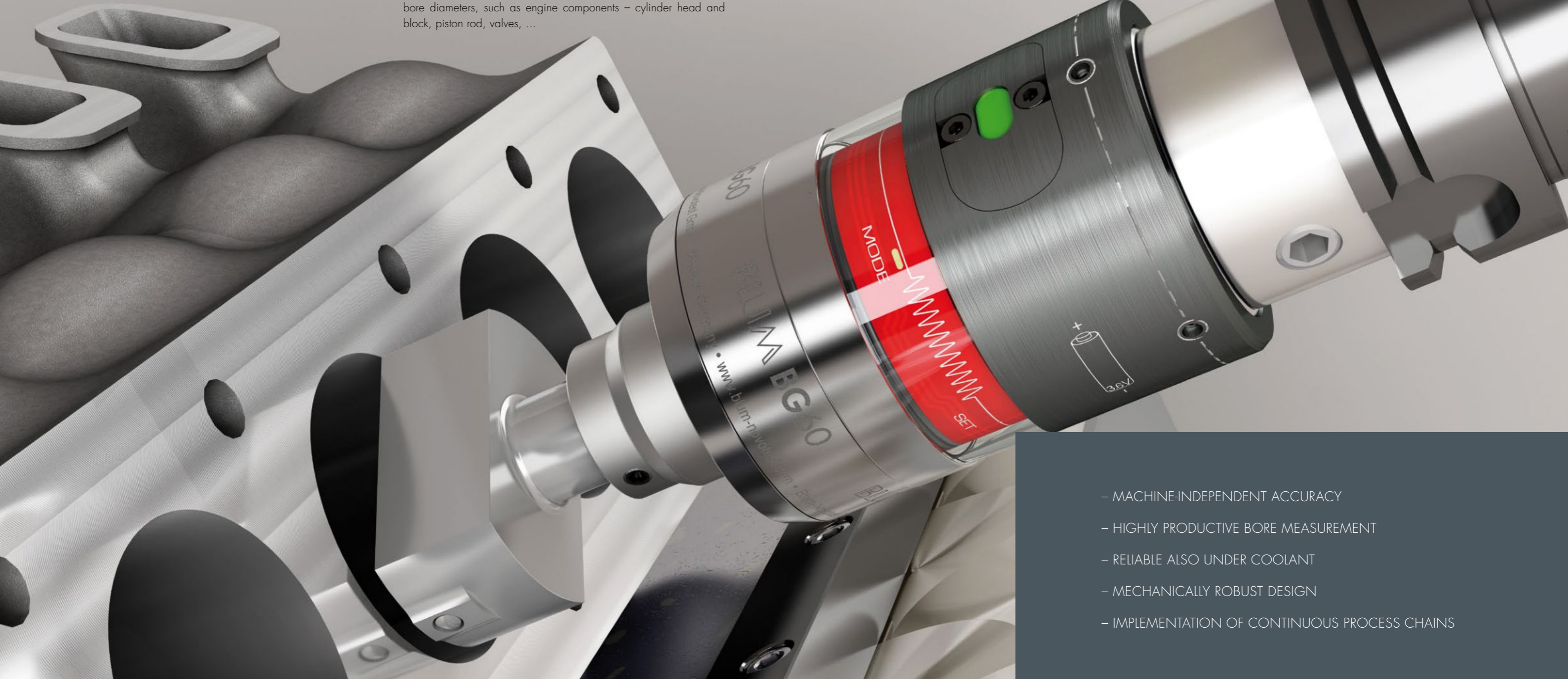





- MACHINE-INDEPENDENT ACCURACY
- HIGHLY PRODUCTIVE BORE MEASUREMENT
- RELIABLE ALSO UNDER COOLANT
- MECHANICALLY ROBUST DESIGN
- IMPLEMENTATION OF CONTINUOUS PROCESS CHAINS



Software **BG-VISION**

MEASUREMENT SOFTWARE FOR BORE GAUGES

BG-VISION is an innovative measurement, visualisation and analysis software solution for bore gauges from BLUM. The application, which has been redesigned from the ground up, features an entirely new approach to functionality and ease of use. With its intuitive operating design, it can be used to generate, document and analyse complex measurement sequences quickly and easily.

-  Diameter Measurement
-  Wear Compensation
-  Adaptive Machining
-  Mass Production

- SIMPLE, PC-BASED USER SOLUTION FOR CREATING COMPLEX MEASUREMENT PROGRAMS
- RECORDING, VISUALISATION AND STATISTICAL ANALYSIS
- COMFORTABLE HARDWARE ADMINISTRATION, INCL. SERIAL NUMBERS, SOFTWARE VERSIONS AND SYSTEM SPECIFICATIONS
- POSSIBLE TO OPERATE WITHOUT AN ADDITIONAL MEASUREMENT COMPUTER (IPC)
- Q-DAS INTERFACE FOR MEASUREMENT SYSTEM ANALYSIS (OPTION)
- PROCESS CONTROL FOR THE IMPLEMENTATION OF CLOSED PRODUCTION SEQUENCES (OPTION)

Visualisation of the measuring results

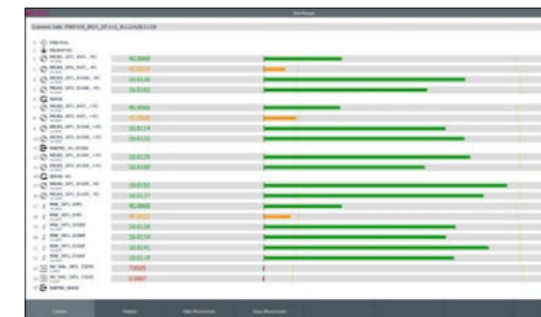

Statistical analysis

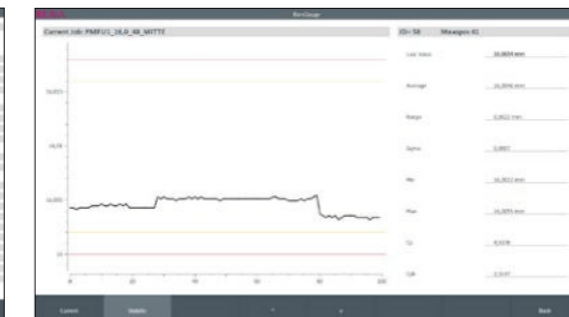

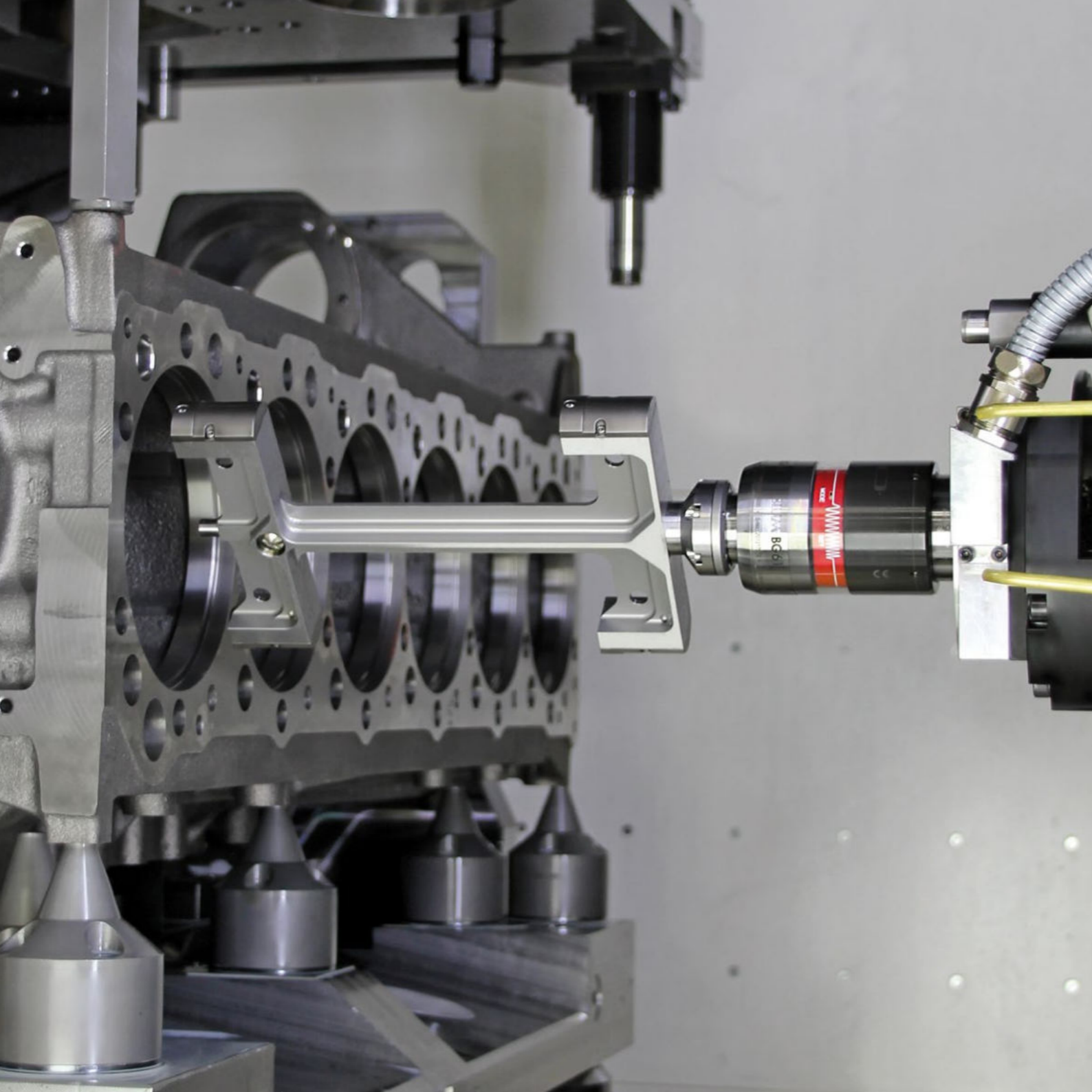

Bore Gauges **BG60** | **BG61**

HIGHLY PRODUCTIVE BORE MEASUREMENT

BLUM bore gauges are machine-independent measuring systems for quality monitoring of tight tolerances in highly productive machine tools and transfer lines. The determination of compensation values in the initial setting permits a highly accurate process control, e.g. in the production of engines, valves or compressors.

Measurement of a steering knuckle bore before slitting



Measuring principles of the BG series

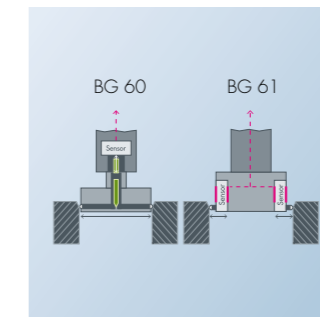

-  Radio Transmission
-  Position Measurement
-  Diameter Measurement
-  Roundness Measurement
-  Cylindricity Measurement
-  Concentricity Measurement
-  Adaptive Machining
-  Measurement with Coolant
-  Mass Production
-  Wear Compensation

Bore Gauge

BG60

BG61

SIZE

Ø 63 mm

Ø 63 mm

TRANSMISSION METHOD

Radio

Radio

MEASURING ELEMENTS

1

up to 8

RESOLUTION

12 bit / 0.15 µm

12 bit / 0.15 µm



Measuring Systems **MG80** | **TG82**

TEMPERATURE MEASUREMENT & MORE

MG80: Measuring system for the acquisition of workpiece temperature, presence of the workpiece, clamping pressure or tool breakage during machining.

TG82: Contact measuring system that can be exchanged via the tool magazine to determine the workpiece temperature.

Both systems transmit the recorded data wirelessly to the control via BRC radio technology. In the case of a temperature measurement, compensation values can be calculated that are directly incorporated into the machining process.

MG80 – with up to 8 sensors in the workpiece clamping device

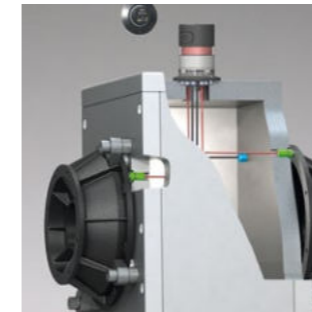

MG80: Sensors and transmission unit

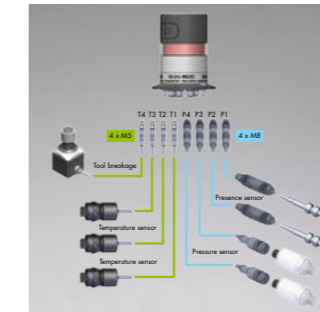

-  Radio Transmission
-  Temperature Measurement
-  Pressure Measurement
-  Presence of the workpiece
-  Tool Breakage Detection
-  Modular System
-  Adaptive Machining
-  Mass Production
-  Temperature Compensation

Measuring system

MG80

TG82

SIZE

Ø 63 mm

Ø 63 mm

TRANSMISSION METHOD

Radio

Radio

FIELD OF APPLICATION

Workpiece clamping device

Machine spindle



09



SALES & SERVICE

FOCUS ON PRODUCTIVITY

Profit from our comprehensive services to ensure maximum efficiency, in-process reliability and availability for your production. Our worldwide sales and service network enables us to provide optimum support and very short response times.

- RETROFIT OPTIONS FOR YOUR MACHINE TOOL
- TRAININGS AND WORKSHOPS
- TELEPHONE CUSTOMER SUPPORT
- SOLUTIONS FOR CUSTOM MEASUREMENT TASKS
- EXPRESS DELIVERY FOR URGENT SPARE PARTS REQUIREMENTS
- PRODUCT PRESENTATIONS AND ON-SITE CONSULTING

10



INTERNATIONAL

THERE FOR YOU – WORLDWIDE

- BLUM SUBSIDIARY
- BLUM SALES & SERVICE
- SYSTEM INTEGRATOR

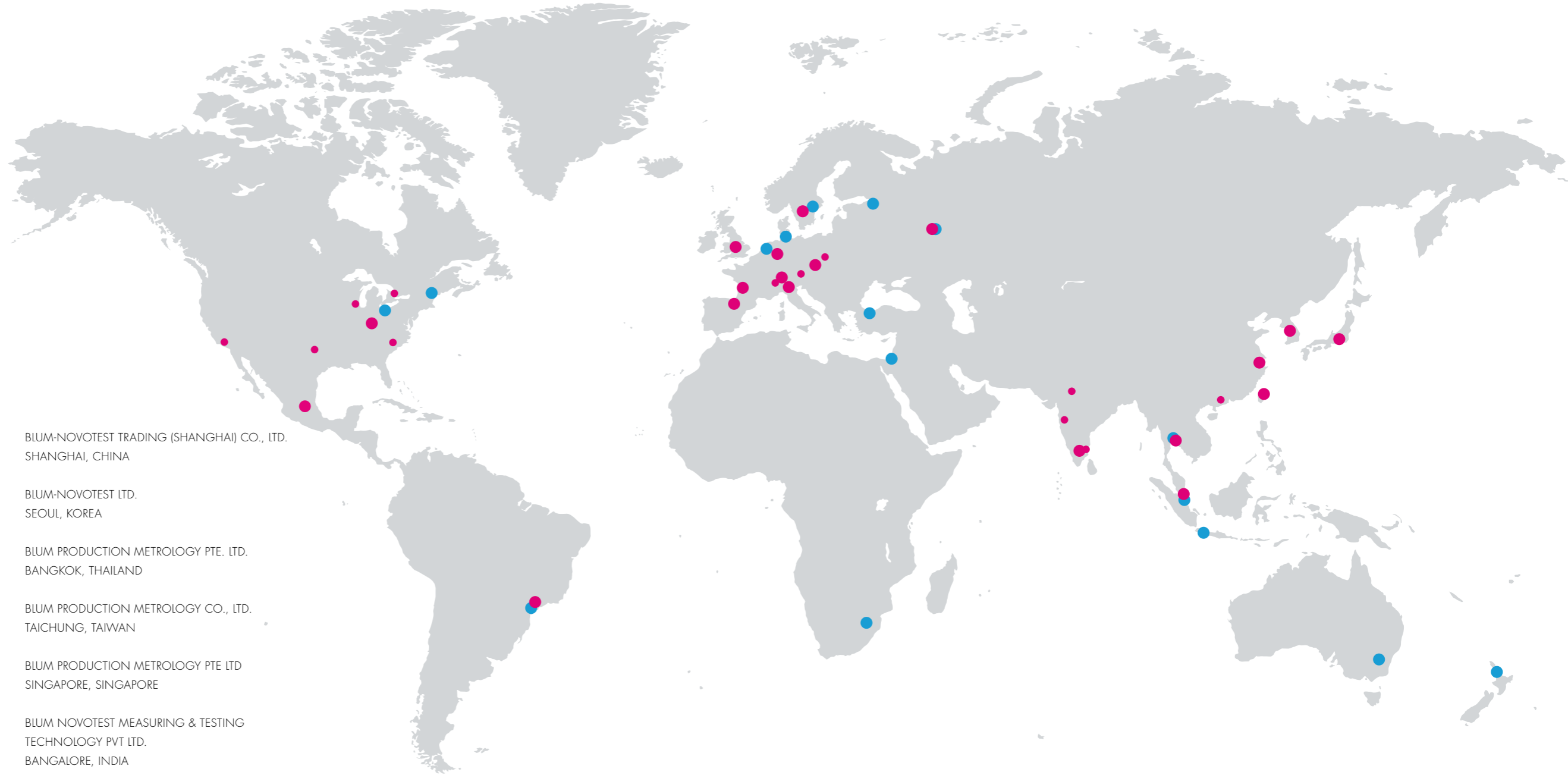

BLUM-NOVOTEST GMBH
GRUENKRAUT, GERMANY

BLUM-NOVOTEST GMBH
TEST ENGINEERING DIVISION
WILICH, GERMANY

BLUM-NOVOTEST S.R.L
COMO, ITALY

BLUM-NOVOTEST LTD.
BIRMINGHAM, ENGLAND

BLUM-NOVOTEST SARL
BORDEAUX, FRANCE

BLUM-NOVOTEST S.R.O.
KROMĚŘÍŽ, CZECH REPUBLIC

BLUM-NOVOTEST AB
SKÖVDE, SWEDEN

BLUM-NOVOTEST IBÉRICA, S.L.
BILBAO, SPAIN

OOO BLUM-NOVOTEST
NIZHNY NOVGOROD, RUSSIA

BLUM-NOVOTEST, INC.
CINCINNATI, USA

BLUM-NOVOTEST S. DE R.L. DE C.V.
SANTIAGO DE QUERÉTARO, MEXIKO

BLUM-NOVOTEST SISTEMAS DE MEDIÇÃO LTDA
SAO PAULO, BRAZIL

BLUM-NOVOTEST K.K
NAGOYA, JAPAN

BLUM-NOVOTEST TRADING (SHANGHAI) CO., LTD.
SHANGHAI, CHINA

BLUM-NOVOTEST LTD.
SEOUL, KOREA



BLUM PRODUCTION METROLOGY PTE. LTD.
BANGKOK, THAILAND

BLUM PRODUCTION METROLOGY CO., LTD.
TAICHUNG, TAIWAN

BLUM PRODUCTION METROLOGY PTE LTD
SINGAPORE, SINGAPORE

BLUM NOVOTEST MEASURING & TESTING
TECHNOLOGY PVT LTD.
BANGALORE, INDIA







11 **NOVOTEST TEST ENGINEERING DIVISION** THE SPECIALIST IN TESTING TECHNOLOGY

-  Transmission Test Stands
-  Drive Shaft Test Stands
-  Hydraulic Test Stands
-  Spindle Test Stands
-  Special Equipment
-  Software

NOVOTEST is the specialist in test stands for the automotive and hydraulics industries within Blum-Novotest GmbH. Planning, designing and engineering of functional, capacity and durability test stands, as well as the integration into customers automation systems, is our scope of supply and services.

12 **DIVISION MEASURING MACHINES** POST-PROCESS SOLUTIONS

The business division Measuring Machines develops and manufactures solutions for dimensional and geometric inspection for inline 100 % inspection in series production. In addition, you will find a competent partner here for specific special measuring and testing requirements according to customer requirements incl. automation or for integration.

-  Multipoint Gauging Machines
-  Measuring and Automation Cells
-  Flexible 2D Measuring Machines
-  Software
-  Spindle Test Stands
-  Crack Detection Testing Machines
-  Special Measuring Systems

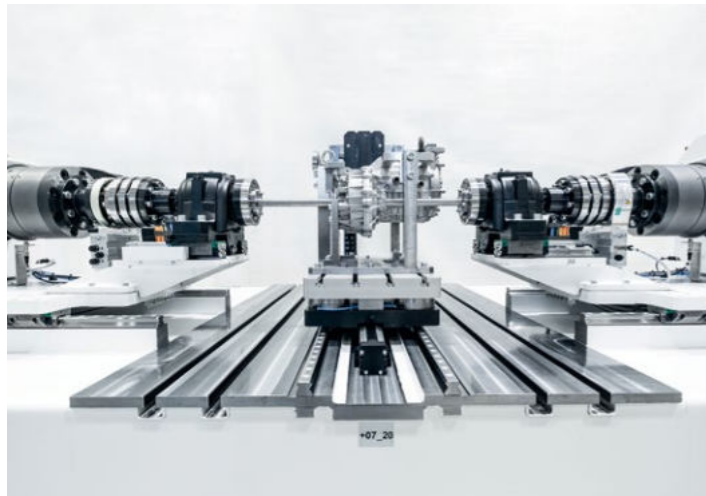

E-Drive test bench for electric axle drives

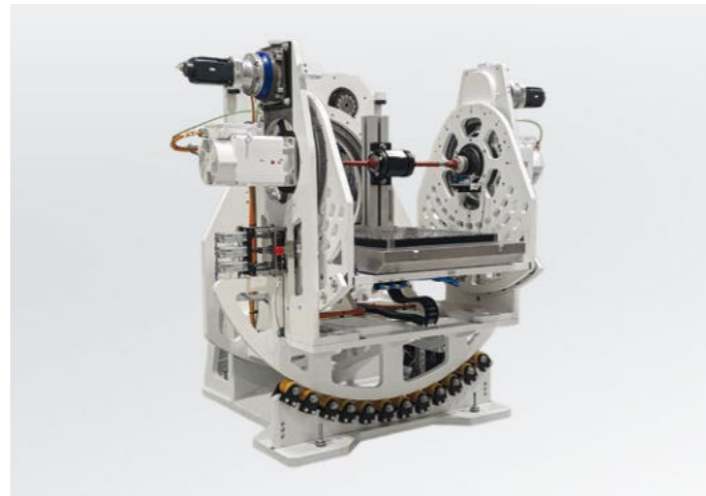

Swivel test bench for E-Drive and AWD products



Multipoint metrology



Spindle test stand

www.blum-novotest.com